

colors book

FALL 2023

colors book

FALL 2023

atlasPLAN



DOWNLOAD
CATALOG

Atlas Plan is the Atlas Concorde brand that specialises in the creation of large-size ceramic slabs.

Atlas Plan è il brand di Atlas Concorde specializzato nella creazione di lastre ceramiche di grandi dimensioni.

Atlas Plan est une marque d'Atlas Concorde spécialisée dans la création de dalles en céramique de grandes dimensions.

Atlas Plan ist ein Markenzeichen von Atlas Concorde, das sich auf die Kreation großformatiger Platten spezialisiert hat.

Atlas Plan es una marca de Atlas Concorde especializada en la creación de placas cerámicas de gran tamaño.

Atlas Plan – это бренд компании Atlas Concorde, специализирующийся на производстве керамических плит больших размеров.



new colors

MARBLE LOOK

precious brown	18
calacatta meraviglia	20
onyx white	24

CONCRETE LOOK

boost balance ash	28
-------------------	----

MARBLE LOOK

calacatta bernini NV*	34
calacatta apuano	36
calacatta extra NV*	40
calacatta antique	46
calacatta imperiale NV*	48
calacatta delicato	51
calacatta prestigio	52
crystal white	56
white cloud	58
bianco dolomite	59
statuario supremo NV*	62
travertino pearl	68
travertino sand	69
cream prestige	70
cremo delicato	72
desert soul	74
exotic wave	76
exotic green	78
fior di bosco	80
light grey stone	82
grey stone	83
nero marquina	84
black atlantis	86

STONE LOOK

kone gypsum	88
boost stone ivory	89
boost mineral grey NB*	90
kone mix NB*	91
basaltina volcano NB*	92
soapstone dark NB*	93

CONCRETE LOOK

boost white	94
boost natural ecru	98
boost pro clay	100
boost grey	102
boost smoke	106
boost pro taupe	110
boost tarmac	112

SOLID LOOK

absolute white	116
absolute black	117
black lava	118

METAL LOOK

blaze iron	119
------------	-----





A system of indoor and outdoor surfaces: floors, walls, and decors.



Large slabs for kitchen countertops, tables, and furnishings.



Washbasins and bathroom furnishings in combination with Atlas Concorde surfaces.

Our product system is designed to create complete, coordinated interiors and exteriors. With our brands we offer a stylistic selection of functional surfaces and products for every space.

Il nostro sistema di prodotto è pensato per realizzare ambienti completi e coordinati. Attraverso i nostri brand offriamo una proposta stilistica di superfici e prodotti funzionali per ogni spazio.

Notre système de produits est conçu pour créer des ambiances complètes et coordonnées. À travers nos marques, nous offrons une proposition stylistique de surfaces et de produits fonctionnels pour chaque espace.

Unser Produktsystem ist darauf ausgelegt, Räumlichkeiten komplett und koordiniert zu gestalten. Mit unseren Marken bieten wir stilistisch ansprechende Beläge und funktionelle Produkte für jedes Ambiente.

Nuestro sistema de productos está diseñado para crear ambientes completos y combinados. A través de nuestras marcas, ofrecemos una propuesta estilística de superficies y productos funcionales para todos los espacios.

Наша продуктовая система задумана для комплексного оформления интерьеров. Посредством наших брендов мы предлагаем широкий ассортимент функциональных изделий и плитки для любого пространства.

large sizes
for any application

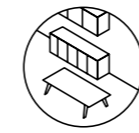

Furniture

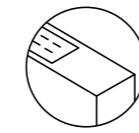

Countertops

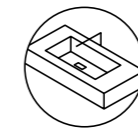

Sinks

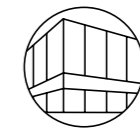

Facades

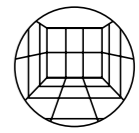

Wall, Floor



not rectified porcelain slabs

162 x 324 cm

± 12, 20 mm

159 x 324 cm

± 20 mm

rectified monocaliber porcelain slabs

160 x 320 cm

± 6 mm

natura technologies

The look of natural marble.

The vein pattern is reproduced through the full thickness of the slab.



L'effetto del marmo naturale.

La venatura attraversa l'intero spessore della lastra.

L'effet du marbre naturel.

La veine traverse toute l'épaisseur de la plaque.

Die Wirkung von Naturmarmor nach.

Die Maserung durchzieht die gesamte Plattenstärke.

El efecto del mármol natural.

El veteado surca todo el espesor de la placa.

эффект натурального мрамора.

Рисунок вен проходит по всей толщине плитки.

The texture of natural stone.

The aesthetics of natural stone across both the surface and body of the slab.



La matericità della pietra naturale.

L'estetica della pietra naturale sia in superficie che nel corpo della lastra.

La matière de la pierre naturelle.

L'esthétique de la pierre naturelle aussi bien sur la surface que dans le corps de la plaque.

Die für Naturstein typische Stofflichkeit.

Der Naturstein-Optik sowohl an der Oberfläche als auch durch die Masse der Platte.

El aspecto de la piedra natural.

La estética de la piedra natural tanto en la superficie como en el cuerpo de la placa.

фактура натурального камня.

Воссоздать эстетику натурального камня, как на поверхности, так и внутри плиты.



our finishes

The technical data sheets can be viewed and displayed on www.atlasplan.com
È possibile visionare e scaricare le schede tecniche sul sito www.atlasplan.com
Les fiches techniques peuvent être affichées et téléchargées sur le site www.atlasplan.com
Die technischen Merkblätter können unter www.atlasplan.com eingesehen und heruntergeladen werden
Es posible consultar y descargar las fichas técnicas en la página web www.atlasplan.com
Технические спецификации можно посмотреть и скачать на веб-сайте www.atlasplan.com

polished



silk



[BACK TO INDEX](#)

satin



leathered

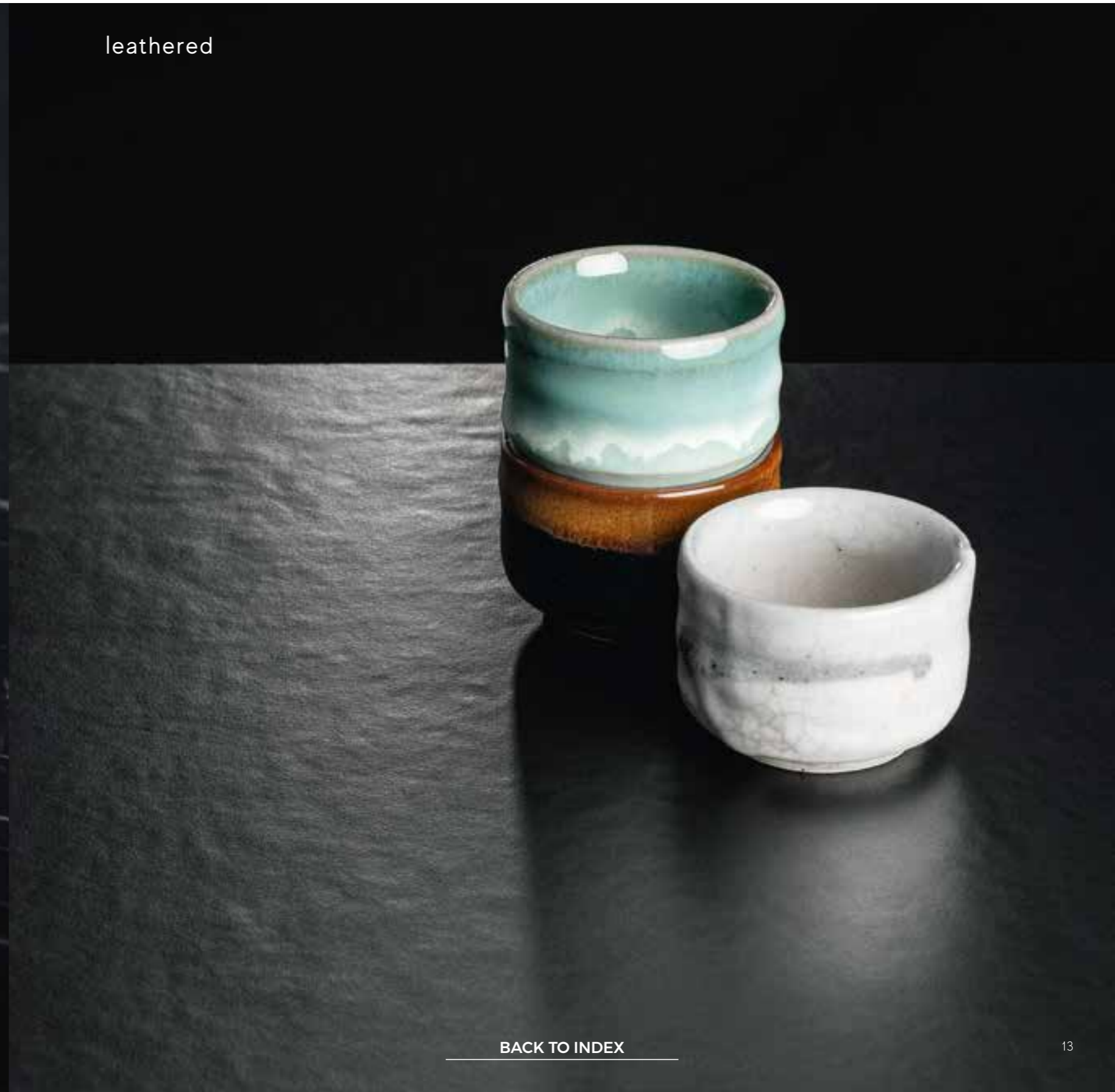

The shades of finishes reproduced here may not correspond perfectly with actual shades, due to limitations relating to the printing on paper.
Le tonalità delle finiture qui riprodotte potrebbero non corrispondere fedelmente a quelle reali, a causa dei limiti connessi alle tecniche di stampa su carta.
Les nuances des finitions reproduites ici pourraient ne pas correspondre exactement aux nuances réelles, à cause des limites liées aux techniques d'imprimerie sur papier.
Die in den Abbildungen gezeigten Farbtöne könnten aus drucktechnischen Gründen, die beim Druck auf Papier in Kauf zu nehmen sind, von den tatsächlichen Farben abweichen.
Los tonos de acabado que se reproducen aquí podrían no reflejar fielmente la realidad debido a los límites impuestos por las técnicas de impresión en papel.
По техническим причинам, связанным с ограничениями при печати на бумаге, воспроизводимые здесь оттенки обработки поверхностей могут немного отличаться от фактических оттенков.

hammered



matte



new colors

FALL 2023

NEW COLOR

precious brown



SIZE	THICKNESS	FINISH	CODE
not rectified			
162 x 324 cm 63 3/4" x 127 1/2"	± 12 mm	Silk	AJHF
> BOOKMATCH	± 12 mm	Silk	AJHG
rectified monocaliber			
160 x 320 cm 63" x 126"	± 6 mm	Silk	AKGB
> BOOKMATCH	± 6 mm	Silk	AKGC

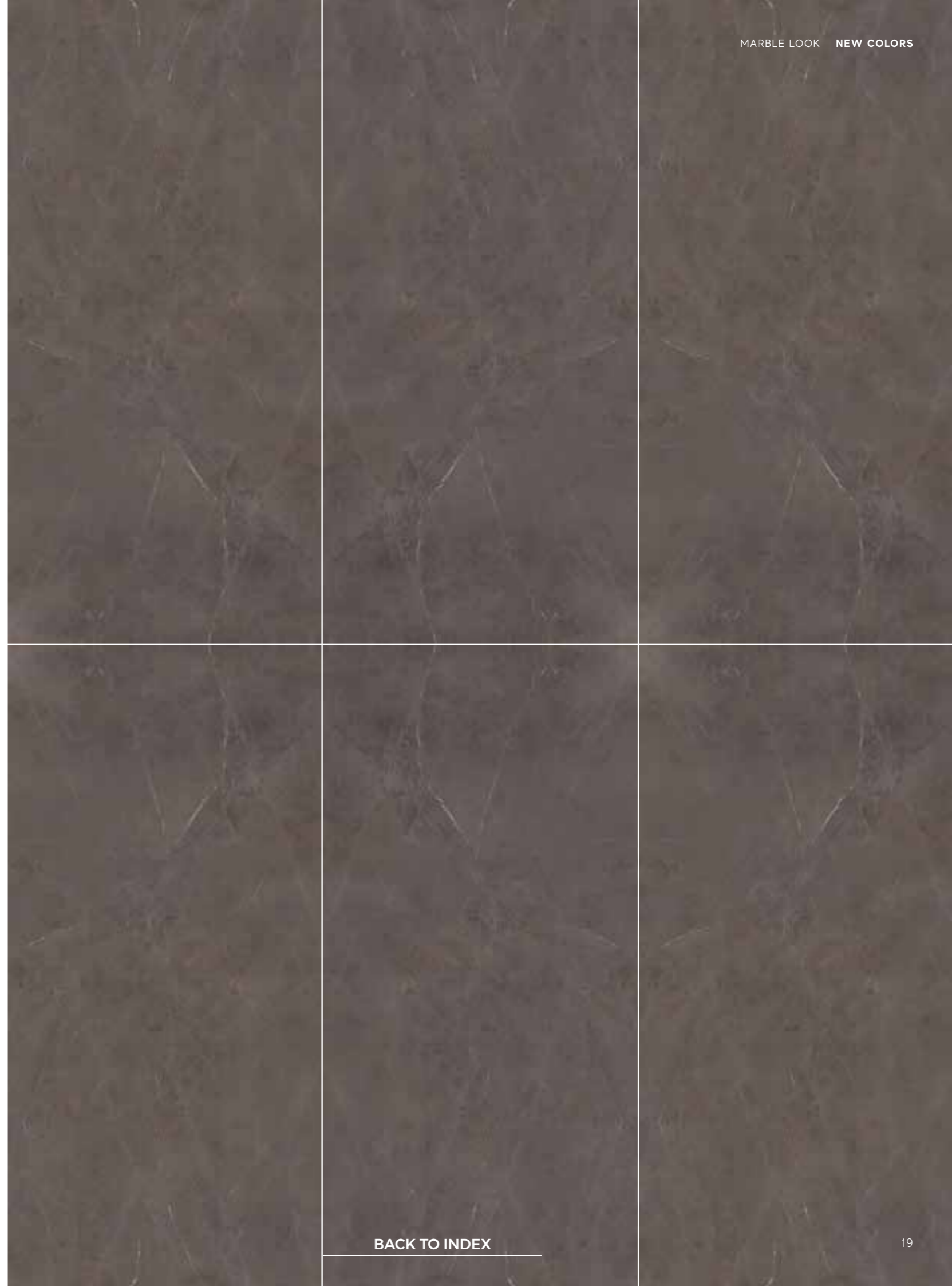

NEW COLOR

calacatta meraviglia



SIZE	THICKNESS	FINISH	CODE
not rectified			
162 x 324 cm 63 3/4" x 127 1/2"	± 12 mm	Polished Silk	AJHH AJHB
> BOOKMATCH	± 12 mm	Polished Silk	AJHI AJHC

Also available in other sizes in the Atlas Concorde range.

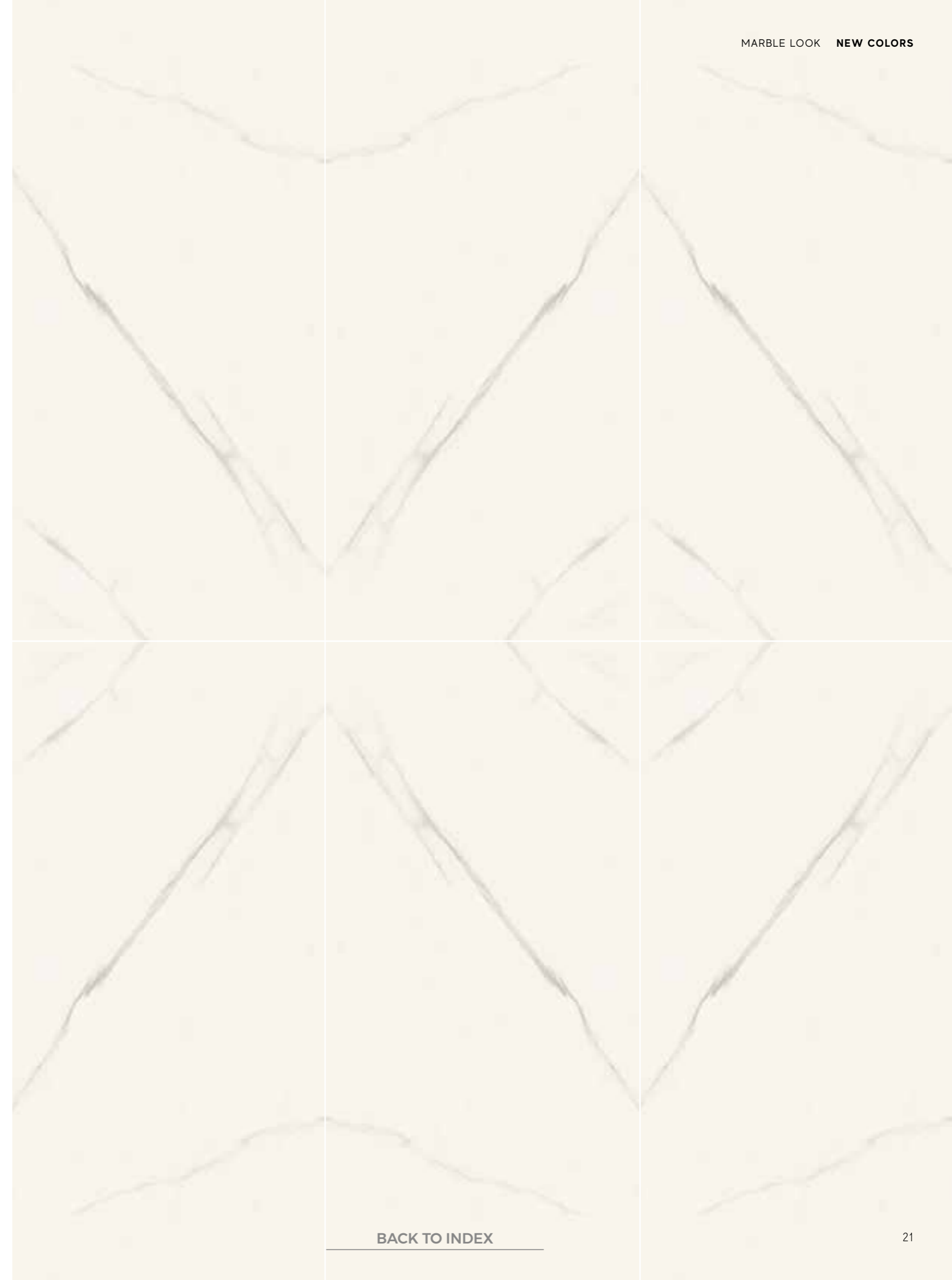

[BACK TO INDEX](#)

NEW COLOR

calacatta meraviglia



SIZE	THICKNESS	FINISH	CODE
rectified monocaliber			
160 x 320 cm 63" x 126"	± 6 mm	Polished	AJJ9
> BOOKMATCH	± 6 mm	Polished	AJKA
> ENDLESS	± 6 mm	Polished Matte	AJG9 AJSZ
> KIT ENDLESS	± 6 mm	Polished Matte	AKFI AKFJ



patterns

BOOKMATCH

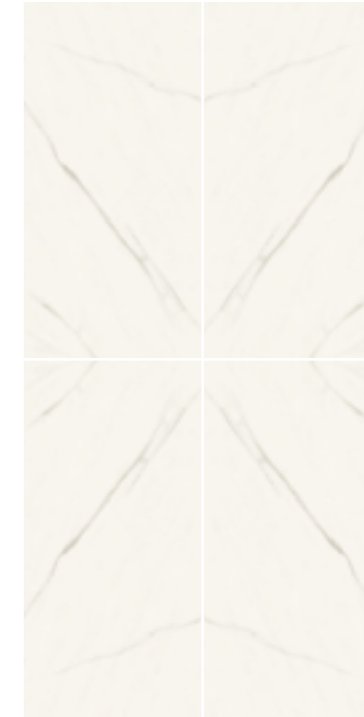
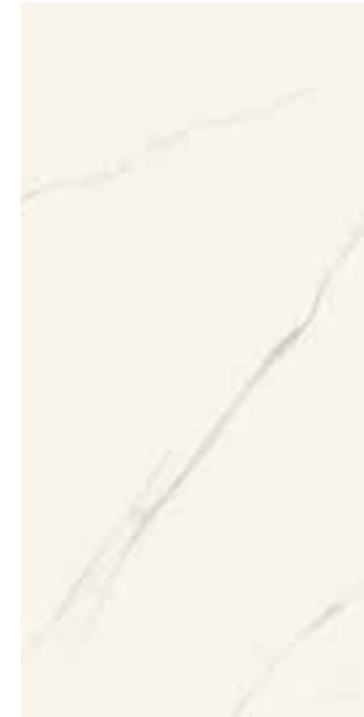
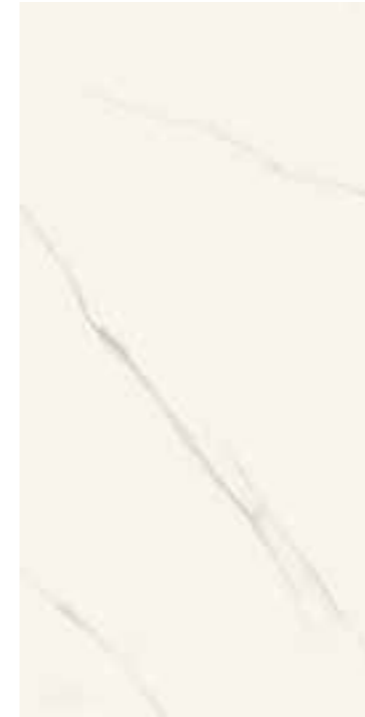

ENDLESS

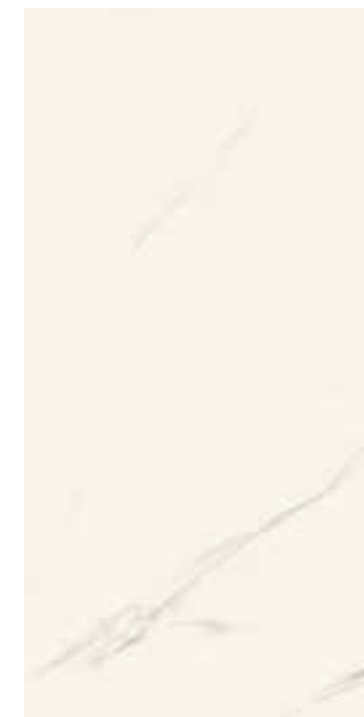
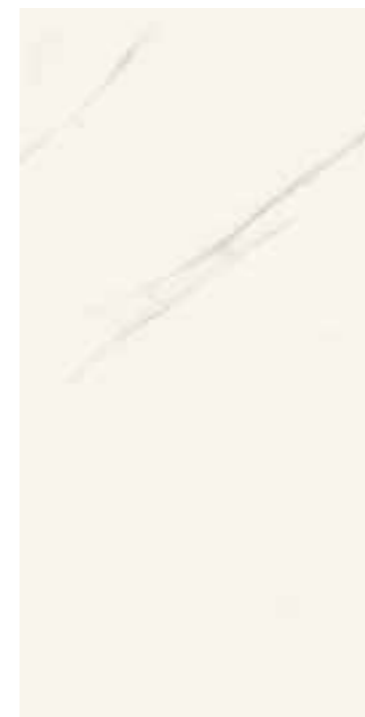

Also available in other sizes in the Atlas Concorde range.

[BACK TO INDEX](#)

NEW COLOR

onyx white



SIZE	THICKNESS	FINISH	CODE
not rectified			
162 x 324 cm 63 3/4" x 127 1/2"	± 12 mm	Polished Silk	AJHJ AJHD
> BOOKMATCH	± 12 mm	Polished Silk	AJHK AJHE

Also available in other sizes in the Atlas Concorde range.



[BACK TO INDEX](#)

NEW COLOR

onyx white



SIZE	THICKNESS	FINISH	CODE
rectified monocaliber			
160 x 320 cm 63" x 126"	± 6 mm	Polished	AJHA
> BOOKMATCH	± 6 mm	Polished	AJKB

Also available in other sizes in the Atlas Concorde range.



patterns

BOOKMATCH

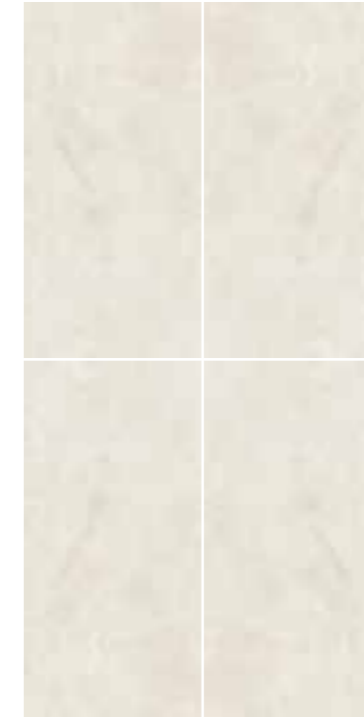



NEW COLOR

boost balance ash



SIZE	THICKNESS	FINISH	CODE
not rectified			
162 x 324 cm 63 3/4" x 127 1/2"	± 12 mm	Matte	AJKC

Also available in other sizes in the Atlas Concorde range.

[BACK TO INDEX](#)

NEW COLOR

boost balance ash



SIZE	THICKNESS	FINISH	CODE
rectified monocaliber			
160 x 320 cm 63" x 126"	± 6 mm	Matte	AJG4

Also available in other sizes in the Atlas Concorde range.

patterns

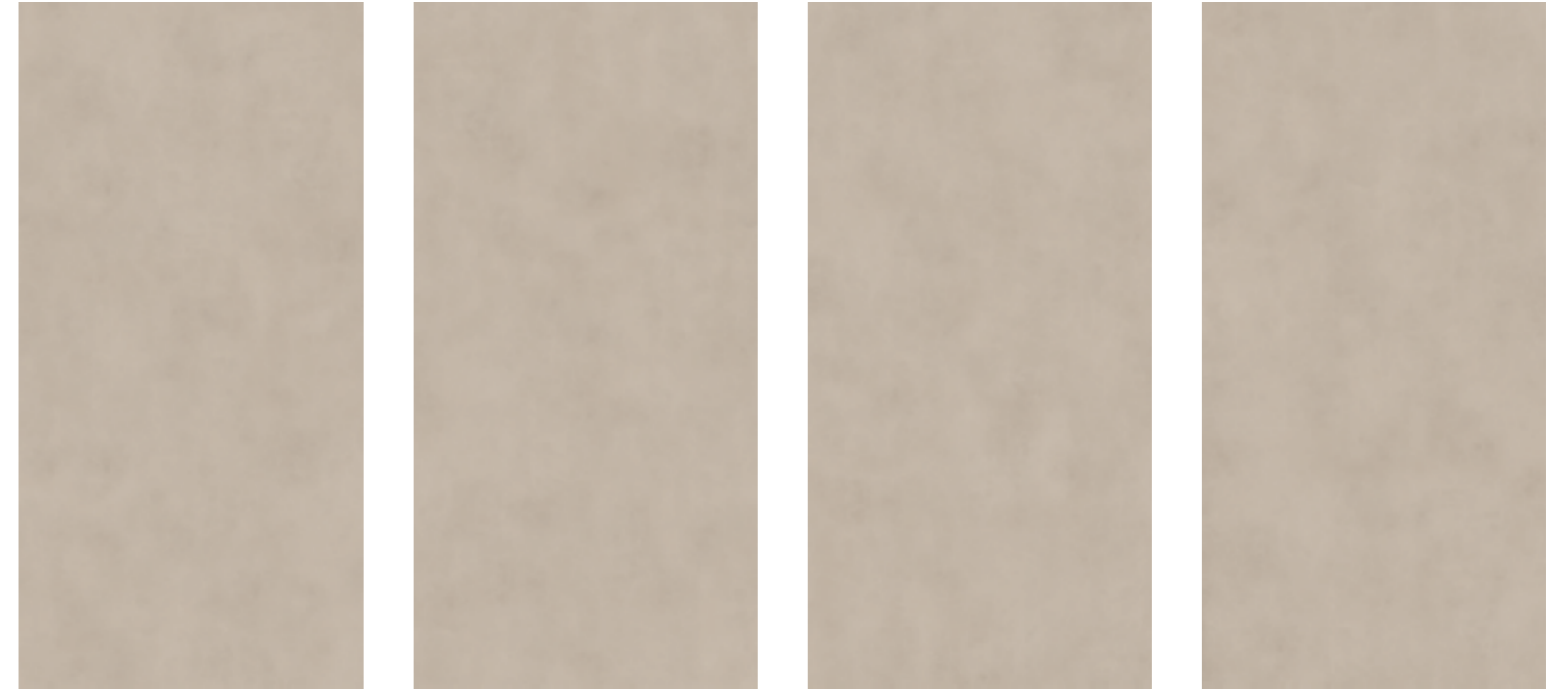

color range

calacatta bernini



SIZE	THICKNESS	FINISH	CODE
not rectified			
162 x 324 cm 63 3/4" x 127 1/2"	± 12 mm	Polished Silk	AF5E AF5B
> BOOKMATCH	± 12 mm	Polished Silk	AF5K AF5C
159 x 324 cm 62 3/4" x 127 1/2"	± 20 mm	Polished Matte	AIRK AIRL
> NATURA VEIN TECH			
rectified monocaliber			
160 x 320 cm 63" x 126"	± 6 mm	Polished	AJRT
> BOOKMATCH	± 6 mm	Polished	AJRU

For reasons related to the production process, the graphic of 20mm thick Natura Vein Tech products may not perfectly match the one illustrated here.

Per motivi dipendenti dalle tecniche produttive, la grafica dello spessore 20 mm Natura Vein Tech potrebbe non corrispondere esattamente a quella qui rappresentata.

Pour des raisons liées aux techniques de production, le graphisme de l'épaisseur 20 mm Natura Vein Tech pourrait ne pas correspondre exactement à celui représenté.

Aus fertigungstechnischen Gründen könnte die Grafik bei den Produkten mit 20 mm Stärke und durchgehender Maserung von den hier dargestellten Grafiken abweichen.

Por motivos ajenos a las técnicas de producción, el gráfico de espesor de 20 mm Natura Vein Tech podría no coincidir exactamente con lo aquí ilustrado.

По технологическим причинам изображения, представленные здесь, могут немного отличаться от фактического графического рисунка плитки толщиной 20 мм с прожилками по всей толщине изделия.

Also available in other sizes in the Atlas Concorde range.



calacatta apuano



SIZE	THICKNESS	FINISH	CODE
not rectified			
162 x 324 cm 63 3/4" x 127 1/2"	± 12 mm	Polished Silk	AGRP AGRJ
> BOOKMATCH	± 12 mm	Polished Silk	AGRQ AGRL

Also available in other sizes in the Atlas Concorde range.

calacatta apuano



SIZE	THICKNESS	FINISH	CODE
rectified monocaliber			
160 x 320 cm 63" x 126" > ENDLESS	± 6 mm	Polished	AJRR
> KIT ENDLESS	± 6 mm	Polished	AKFN



patterns

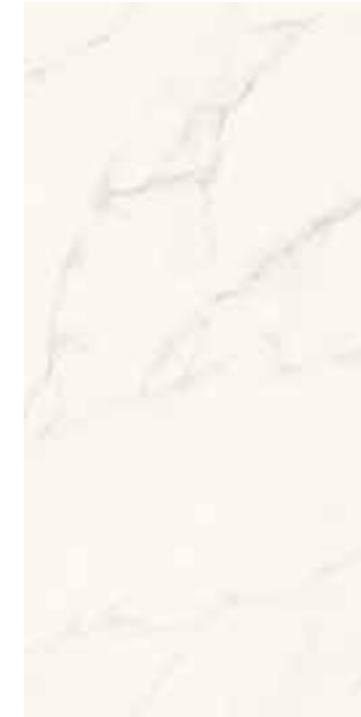
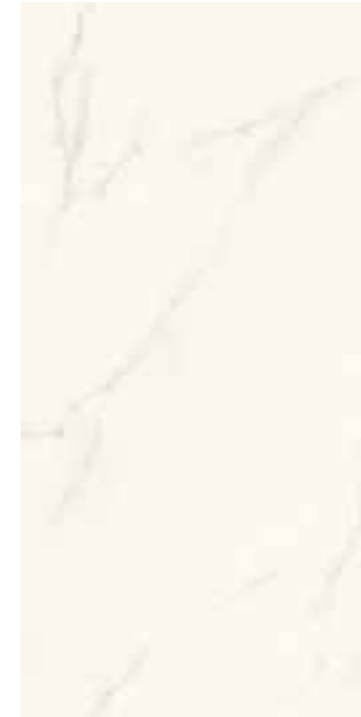
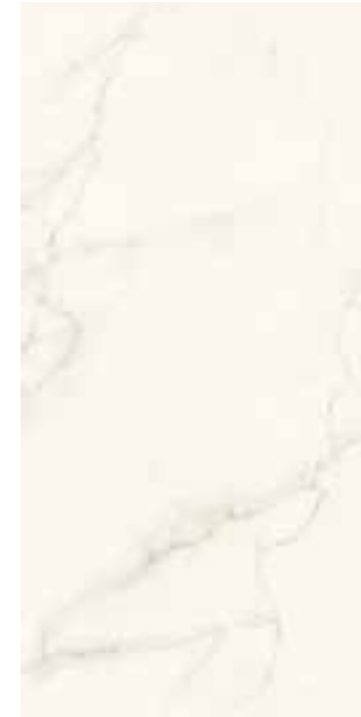

Also available in other sizes in the Atlas Concorde range.

calacatta extra



SIZE	THICKNESS	FINISH	CODE
not rectified			
162 x 324 cm 63 3/4" x 127 1/2"	± 12 mm	Polished Silk	AAVD AA2T
> BOOKMATCH	± 12 mm	Polished Silk	AA2X AMJV
159 x 324 cm 62 3/4" x 127 1/2"	± 20 mm	Polished Matte	AIRN AIRQ
> BOOKMATCH	± 20 mm	Polished Matte	AIRP AIRR

Also available in other sizes in the Atlas Concorde range.





calacatta extra



SIZE	THICKNESS	FINISH	CODE
not rectified			
159 x 324 cm 62 3/4" x 127 1/2"	± 20 mm	Polished Matte	AIRM AILQ
> NATURA VEIN TECH			

For reasons related to the production process, the graphic of 20mm thick Natura Vein Tech products may not perfectly match the one illustrated here.

Per motivi dipendenti dalle tecniche produttive, la grafica dello spessore 20 mm Natura Vein Tech potrebbe non corrispondere esattamente a quella qui rappresentata.

Pour des raisons liées aux techniques de production, le graphisme de l'épaisseur 20 mm Natura Vein Tech pourrait ne pas correspondre exactement à celui représenté.

Aus fertigungstechnischen Gründen könnte die Grafik bei den Produkten mit 20 mm Stärke und durchgehender Maserung von den hier dargestellten Grafiken abweichen.

Por motivos ajenos a las técnicas de producción, el gráfico de espesor de 20 mm Natura Vein Tech podría no coincidir exactamente con lo aquí ilustrado.

По технологическим причинам изображения, представленные здесь, могут немного отличаться от фактического графического рисунка плитки толщиной 20 мм с прожилками по всей толщине изделия.



calacatta extra



SIZE	THICKNESS	FINISH	CODE
rectified monocaliber			
160 x 320 cm 63" x 126"	± 6 mm	Polished Silk	AJKS AJKY
> BOOKMATCH	± 6 mm	Polished Silk	AJKT AJKZ
> ENDLESS	± 6 mm	Polished Matte	AO5U AO5Y
> KIT ENDLESS	± 6 mm	Polished Matte	AKFK AKFM

Also available in other sizes in the Atlas Concorde range.

patterns

BOOKMATCH

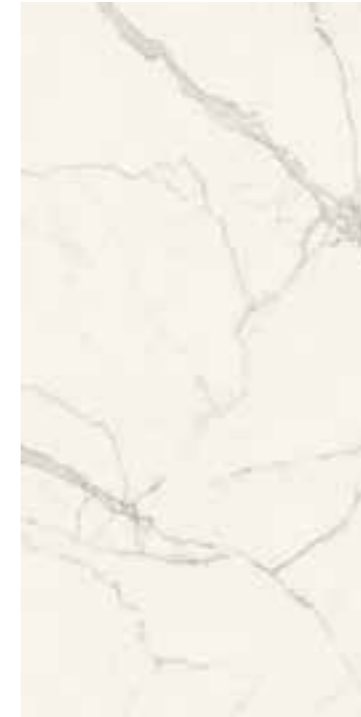
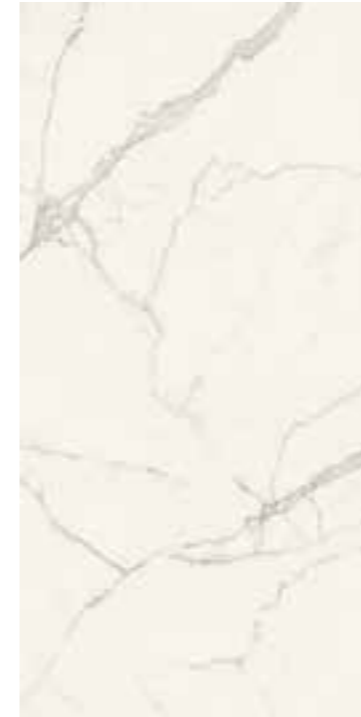

ENDLESS

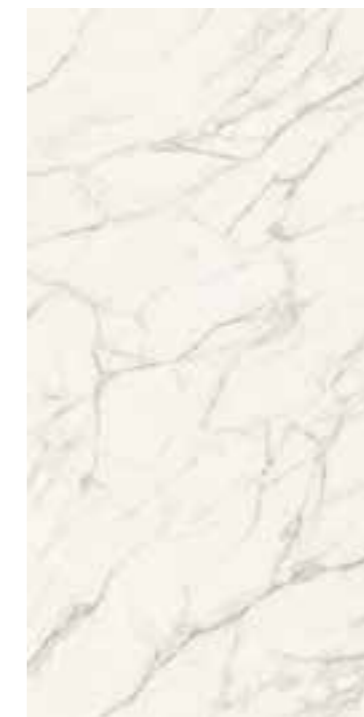
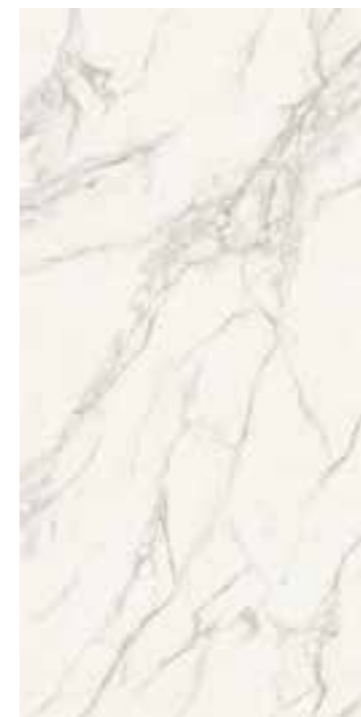

calacatta antique



SIZE	THICKNESS	FINISH	CODE
not rectified			
162 x 324 cm 63 3/4" x 127 1/2"	± 12 mm	Polished	A0XZ
> BOOKMATCH	± 12 mm	Polished	A8T7



calacatta imperiale



SIZE	THICKNESS	FINISH	CODE
not rectified			
162 x 324 cm 63 3/4" x 127 1/2"	± 12 mm	Polished Satin Silk	A0XI A3M9 A0XV
> BOOKMATCH	± 12 mm	Polished Satin Silk	A0XT A4I1 A0XX
rectified monocaliber			
160 x 320 cm 63" x 126"	± 6 mm	Silk	AJK0
> BOOKMATCH	± 6 mm	Silk	AJK1

Also available in other sizes in the Atlas Concorde range.

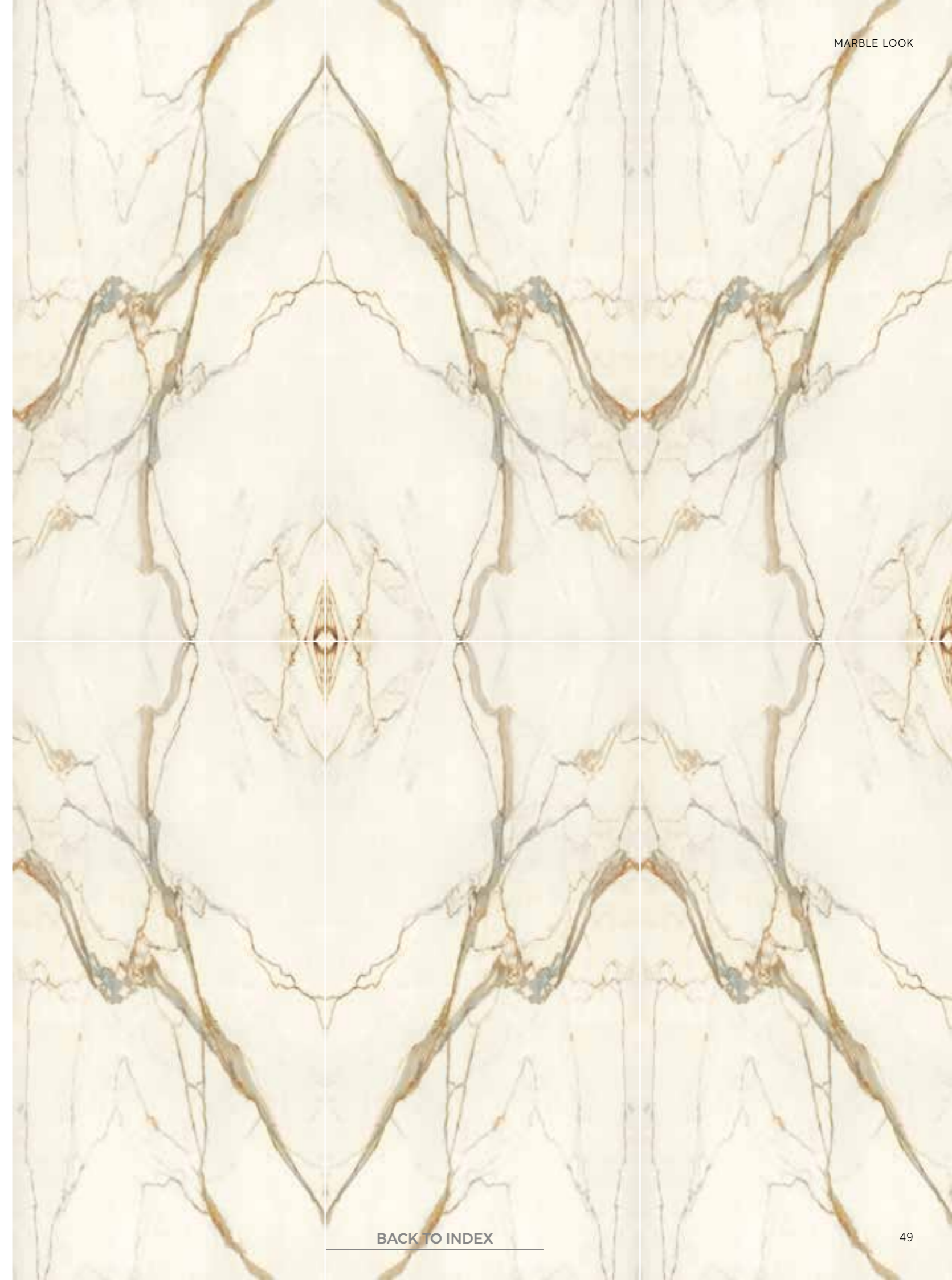

[BACK TO INDEX](#)

calacatta imperiale



SIZE	THICKNESS	FINISH	CODE
------	-----------	--------	------

not rectified

159 x 324 cm 62 3/4" x 127 1/2"	± 20 mm	Polished Matte	AIRS AILP
------------------------------------	---------	-------------------	--------------

NATURA VEIN TECH

For reasons related to the production process, the graphic of 20mm thick Natura Vein Tech products may not perfectly match the one illustrated here.

Per motivi dipendenti dalle tecniche produttive, la grafica dello spessore 20 mm Natura Vein Tech potrebbe non corrispondere esattamente a quella qui rappresentata.

Pour des raisons liées aux techniques de production, le graphisme de l'épaisseur 20 mm Natura Vein Tech pourrait ne pas correspondre exactement à celui représenté.

Aus fertigungstechnischen Gründen könnte die Grafik bei den Produkten mit 20 mm Stärke und durchgehender Maserung von den hier dargestellten Grafiken abweichen.

Por motivos ajenos a las técnicas de producción, el gráfico de espesor de 20 mm Natura Vein Tech podría no coincidir exactamente con lo aquí ilustrado.

По технологическим причинам изображения, представленные здесь, могут немного отличаться от фактического графического рисунка плитки толщиной 20 мм с прожилками по всей толщине изделия.



calacatta delicato



SIZE	THICKNESS	FINISH	CODE
------	-----------	--------	------

not rectified

162 x 324 cm 63 3/4" x 127 1/2"	± 12 mm	Silk	A4T3
------------------------------------	---------	------	------

Also available in other sizes in the Atlas Concorde range.



[BACK TO INDEX](#)

calacatta prestigio



SIZE	THICKNESS	FINISH	CODE
not rectified			
162 x 324 cm 63 3/4" x 127 1/2"	± 12 mm	Silk	A4T0
> BOOKMATCH	± 12 mm	Silk	A4T1

Also available in other sizes in the Atlas Concorde range.



calacatta prestigio



SIZE	THICKNESS	FINISH	CODE
rectified monocaliber			
160 x 320 cm 63" x 126" ENDLESS	± 6 mm	Polished	A4RR
> KIT ENDLESS	± 6 mm	Polished	AKFL

patterns



Also available in other sizes in the Atlas Concorde range.

crystal white



SIZE	THICKNESS	FINISH	CODE
not rectified			
162 x 324 cm 63 3/4" x 127 1/2"	± 12 mm	Polished Silk	A9C2 A9C4
> BOOKMATCH	± 12 mm	Polished Silk	AF2W AF2X
159 x 324 cm 62 3/4" x 127 1/2"	± 20 mm	Polished	AIRJ
> BOOKMATCH	± 20 mm	Polished	AIRH
rectified monocaliber			
160 x 320 cm 63" x 126"	± 6 mm	Polished	AJKU
> BOOKMATCH	± 6 mm	Polished	AJKV

Also available in other sizes in the Atlas Concorde range.



white cloud



SIZE	THICKNESS	FINISH	CODE
not rectified			
162 x 324 cm 63 3/4" x 127 1/2"	± 12 mm	Silk	A4UO



bianco dolomite



SIZE	THICKNESS	FINISH	CODE
not rectified			
162 x 324 cm 63 3/4" x 127 1/2"	± 12 mm	Polished	AAVG
159 x 324 cm 62 3/4" x 127 1/2"	± 20 mm	Polished	AILN

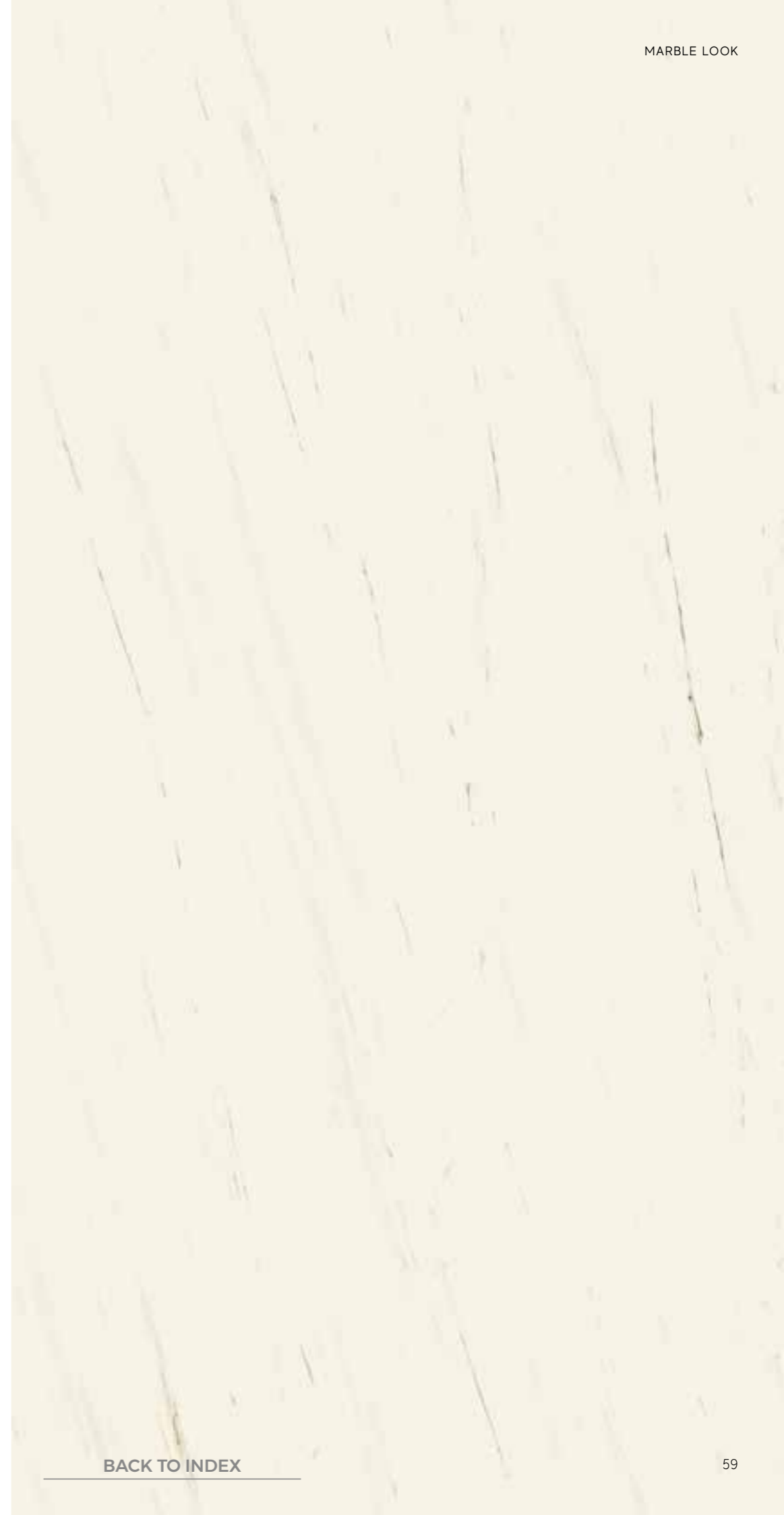

Also available in other sizes in the Atlas Concorde range.

[BACK TO INDEX](#)

bianco dolomite



SIZE	THICKNESS	FINISH	CODE
rectified monocaliber			
160 x 320 cm 63" x 126"	± 6 mm	Polished	AO5X

Also available in other sizes in the Atlas Concorde range.

patterns



statuario supremo



SIZE	THICKNESS	FINISH	CODE
not rectified			
162 x 324 cm 63 3/4" x 127 1/2"	± 12 mm	Polished Satin Silk	AF6A A4I3 A4TX
> BOOKMATCH	± 12 mm	Polished Satin Silk	AF6B A4I5 A4TY

Also available in other sizes in the Atlas Concorde range.



[BACK TO INDEX](#)



statuario supremo

NATURA-VEIN™
TECH



SIZE	THICKNESS	FINISH	CODE
------	-----------	--------	------

not rectified

159 x 324 cm 62 3/4" x 127 1/2"	± 20 mm	Polished Matte	AILO AIRT
------------------------------------	---------	-------------------	--------------

> NATURA VEIN TECH

For reasons related to the production process, the graphic of 20mm thick Natura Vein Tech products may not perfectly match the one illustrated here.

Per motivi dipendenti dalle tecniche produttive, la grafica dello spessore 20 mm Natura Vein Tech potrebbe non corrispondere esattamente a quella qui rappresentata.

Pour des raisons liées aux techniques de production, le graphisme de l'épaisseur 20 mm Natura Vein Tech pourrait ne pas correspondre exactement à celui représenté.

Aus fertigungstechnischen Gründen könnte die Grafik bei den Produkten mit 20 mm Stärke und durchgehender Maserung von den hier dargestellten Grafiken abweichen.

Por motivos ajenos a las técnicas de producción, el gráfico de espesor de 20 mm Natura Vein Tech podría no coincidir exactamente con lo aquí ilustrado.

По технологическим причинам изображения, представленные здесь, могут немного отличаться от фактического графического рисунка плитки толщиной 20 мм с прожилками по всей толщине изделия.

[BACK TO INDEX](#)

statuario supremo



SIZE	THICKNESS	FINISH	CODE
rectified monocaliber			
160 x 320 cm 63" x 126" ENDLESS	± 6 mm	Polished	A4RS
> KIT ENDLESS	± 6 mm	Polished	AKFO



patterns



Also available in other sizes in the Atlas Concorde range.

[BACK TO INDEX](#)

travertino pearl



SIZE	THICKNESS	FINISH	CODE
not rectified			
162 x 324 cm 63 3/4" x 127 1/2"	± 12 mm	Hammered	AF4Z

Also available in other sizes in the Atlas Concorde range.

travertino sand



SIZE	THICKNESS	FINISH	CODE
not rectified			
162 x 324 cm 63 3/4" x 127 1/2"	± 12 mm	Hammered	A647
rectified monocaliber			
160 x 320 cm 63" x 126"	± 6 mm	Hammered	AJKQ

Also available in other sizes in the Atlas Concorde range.



cream prestige



SIZE	THICKNESS	FINISH	CODE
not rectified			
162 x 324 cm 63 3/4" x 127 1/2"	± 12 mm	Silk	AAV6

Also available in other sizes in the Atlas Concorde range.

[BACK TO INDEX](#)

cremo delicato



SIZE	THICKNESS	FINISH	CODE
rectified monocaliber			
160 x 320 cm 63" x 126"	± 6 mm	Polished	AO5W

Also available in other sizes in the Atlas Concorde range.

patterns



desert soul



SIZE	THICKNESS	FINISH	CODE
not rectified			
162 x 324 cm 63 3/4" x 127 1/2"	± 12 mm	Polished Silk	A9CW A9CZ
	± 20 mm	Polished	A9C7
> BOOKMATCH	± 12 mm	Polished Silk	A9CX A9C0
	± 20 mm	Polished	A9C8
rectified monocaliber			
160 x 320 cm 63" x 126"	± 6 mm	Polished	AJKG
	> BOOKMATCH	± 6 mm	Polished

Also available in other sizes in the Atlas Concorde range.



exotic wave



SIZE	THICKNESS	FINISH	CODE
not rectified			
162 x 324 cm 63 3/4" x 127 1/2"	± 12 mm	Polished	A9CT
> BOOKMATCH	± 12 mm	Polished	A9CU
rectified monocaliber			
160 x 320 cm 63" x 126"	± 6 mm	Polished	AJRN
> BOOKMATCH	± 6 mm	Polished	AJRO



MARBLE LOOK

[BACK TO INDEX](#)

exotic green



SIZE	THICKNESS	FINISH	CODE
not rectified			
162 x 324 cm 63 3/4" x 127 1/2"	± 12 mm	Polished	A9CN
> BOOKMATCH	± 12 mm	Polished	A9CO
rectified monocaliber			
160 x 320 cm 63" x 126"	± 6 mm	Polished	AJRP
> BOOKMATCH	± 6 mm	Polished	AJRQ

Also available in other sizes in the Atlas Concorde range.

fior di bosco



SIZE	THICKNESS	FINISH	CODE
------	-----------	--------	------

not rectified

162 x 324 cm 63 3/4" x 127 1/2"	± 12 mm	Polished Silk	AIRZ AIBE
---	---------	------------------	--------------

> BOOKMATCH	± 12 mm	Polished Silk	AIR3 AIBF
-------------	---------	------------------	--------------

rectified monocaliber

160 x 320 cm 63" x 126"	± 6 mm	Polished	AJRV
-----------------------------------	--------	----------	------

> BOOKMATCH	± 6 mm	Polished	AJRW
-------------	--------	----------	------

Also available in other sizes in the Atlas Concorde range.

light grey stone



SIZE	THICKNESS	FINISH	CODE
not rectified			
162 x 324 cm 63 3/4" x 127 1/2"	± 12 mm	Silk	AMJ9
rectified monocaliber			
160 x 320 cm 63" x 126"	± 6 mm	Silk	ABGZ

grey stone



SIZE	THICKNESS	FINISH	CODE
not rectified			
162 x 324 cm 63 3/4" x 127 1/2"	± 12 mm	Silk	AAWA
	± 20 mm	Matte	AHH2
rectified monocaliber			
160 x 320 cm 63" x 126"	± 6 mm	Silk	AJKX

Also available in other sizes in the Atlas Concorde range.

nero marquina



SIZE	THICKNESS	FINISH	CODE
not rectified			
162 x 324 cm 63 3/4" x 127 1/2"	± 12 mm	Polished	ANWA
		Satin	A3M5
		Silk	ANVK
	± 20 mm	Matte	AHH5
> BOOKMATCH	± 12 mm	Polished	A6T5
		Satin	A6T6
		Silk	A6T4
rectified monocaliber			
160 x 320 cm 63" x 126"	± 6 mm	Polished Silk	AJKW AJK2

Also available in other sizes in the Atlas Concorde range.

black atlantis



SIZE	THICKNESS	FINISH	CODE
not rectified			
162 x 324 cm 63 3/4" x 127 1/2"	± 12 mm	Polished Silk	A9CK A8XV
> BOOKMATCH	± 12 mm	Polished Silk	A9CL A8XW

Also available in other sizes in the Atlas Concorde range.

kone gypsum



SIZE	THICKNESS	FINISH	CODE
not rectified			
162 x 324 cm 63 3/4" x 127 1/2"	± 12 mm	Hammered	AMKD

boost stone ivory



SIZE	THICKNESS	FINISH	CODE
not rectified			
162 x 324 cm 63 3/4" x 127 1/2"	± 12 mm	Hammered	A648
rectified monocaliber			
160 x 320 cm 63" x 126"	± 6 mm	Hammered	AJRX

Also available in other sizes in the Atlas Concorde range.

boost mineral grey



SIZE	THICKNESS	FINISH	CODE
not rectified			
162 x 324 cm 63 3/4" x 127 1/2"	± 12 mm	Hammered	AHV6
rectified monocaliber			
160 x 320 cm 63" x 126"	± 6 mm	Hammered	AKGA

Also available in other sizes in the Atlas Concorde range.

kone mix

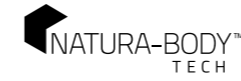

SIZE	THICKNESS	FINISH	CODE
not rectified			
162 x 324 cm 63 3/4" x 127 1/2"	± 12 mm	Hammered	AMSX
rectified monocaliber			
160 x 320 cm 63" x 126"	± 6 mm	Hammered	AJKP

Also available in other sizes in the Atlas Concorde range.

basaltina volcano



SIZE	THICKNESS	FINISH	CODE
------	-----------	--------	------

not rectified

162 x 324 cm 63 3/4" x 127 1/2"	± 12 mm	Hammered	ANVI
	± 20 mm	Hammered	A2XS

rectified monocaliber

160 x 320 cm 63" x 126"	± 6 mm	Hammered	AJKO
----------------------------	--------	----------	------

Also available in other sizes in the Atlas Concorde range.

soapstone dark



SIZE	THICKNESS	FINISH	CODE
------	-----------	--------	------

not rectified

162 x 324 cm 63 3/4" x 127 1/2"	± 12 mm	Hammered	A4UN
	± 20 mm	Hammered	A5I3



boost white



SIZE	THICKNESS	FINISH	CODE
not rectified			
162 x 324 cm 63 3/4" x 127 1/2"	± 12 mm	Hammered	ANVX

Also available in other sizes in the Atlas Concorde range.

boost white



SIZE	THICKNESS	FINISH	CODE
rectified monocaliber			
160 x 320 cm 63" x 126"	± 6 mm	Hammered	AO5Z

Also available in other sizes in the Atlas Concorde range.

patterns





boost natural ecru



SIZE	THICKNESS	FINISH	CODE
not rectified			
162 x 324 cm 63 3/4" x 127 1/2"	± 12 mm	Hammered	A649

Also available in other sizes in the Atlas Concorde range.

[BACK TO INDEX](#)

boost pro clay



SIZE	THICKNESS	FINISH	CODE
rectified monocaliber			
160 x 320 cm 63" x 126"	± 6 mm	Hammered	A0QE

Also available in other sizes in the Atlas Concorde range.

patterns

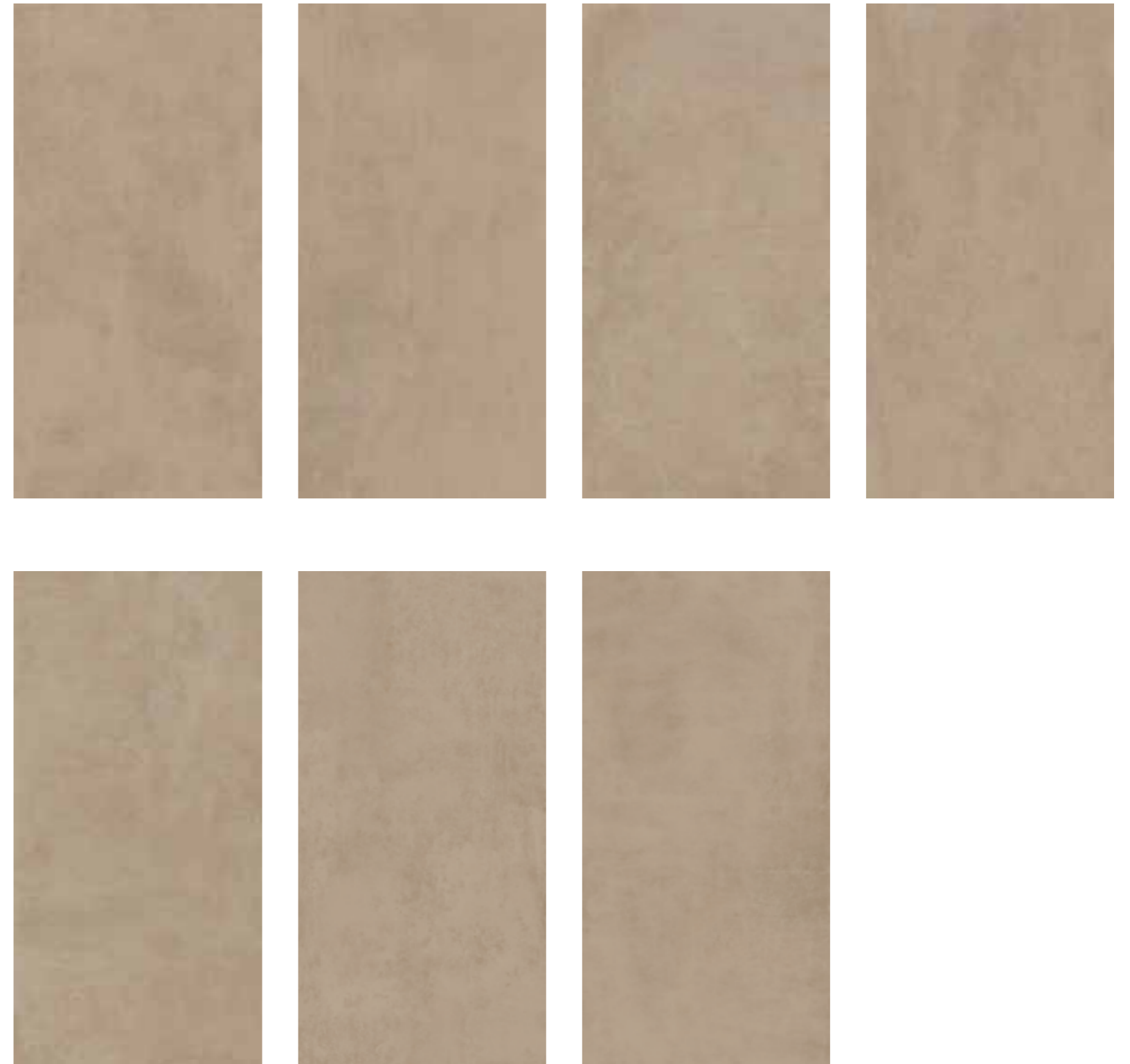

[BACK TO INDEX](#)



boost grey



SIZE	THICKNESS	FINISH	CODE
not rectified			
162 x 324 cm 63 3/4" x 127 1/2"	± 12 mm	Hammered	A65C

Also available in other sizes in the Atlas Concorde range.

boost grey



SIZE	THICKNESS	FINISH	CODE
rectified monocaliber			
160 x 320 cm 63" x 126"	± 6 mm	Hammered	A681

Also available in other sizes in the Atlas Concorde range.

patterns





boost smoke



SIZE	THICKNESS	FINISH	CODE
not rectified			
162 x 324 cm 63 3/4" x 127 1/2"	± 12 mm	Hammered	ANV0
	± 20 mm	Hammered	A2XV

Also available in other sizes in the Atlas Concorde range.

boost smoke



SIZE	THICKNESS	FINISH	CODE
rectified monocaliber			
160 x 320 cm 63" x 126"	± 6 mm	Hammered	AO50

Also available in other sizes in the Atlas Concorde range.

patterns



boost pro taupe



SIZE	THICKNESS	FINISH	CODE
rectified monocaliber			
160 x 320 cm 63" x 126"	± 6 mm	Hammered	A0QF

Also available in other sizes in the Atlas Concorde range.

patterns

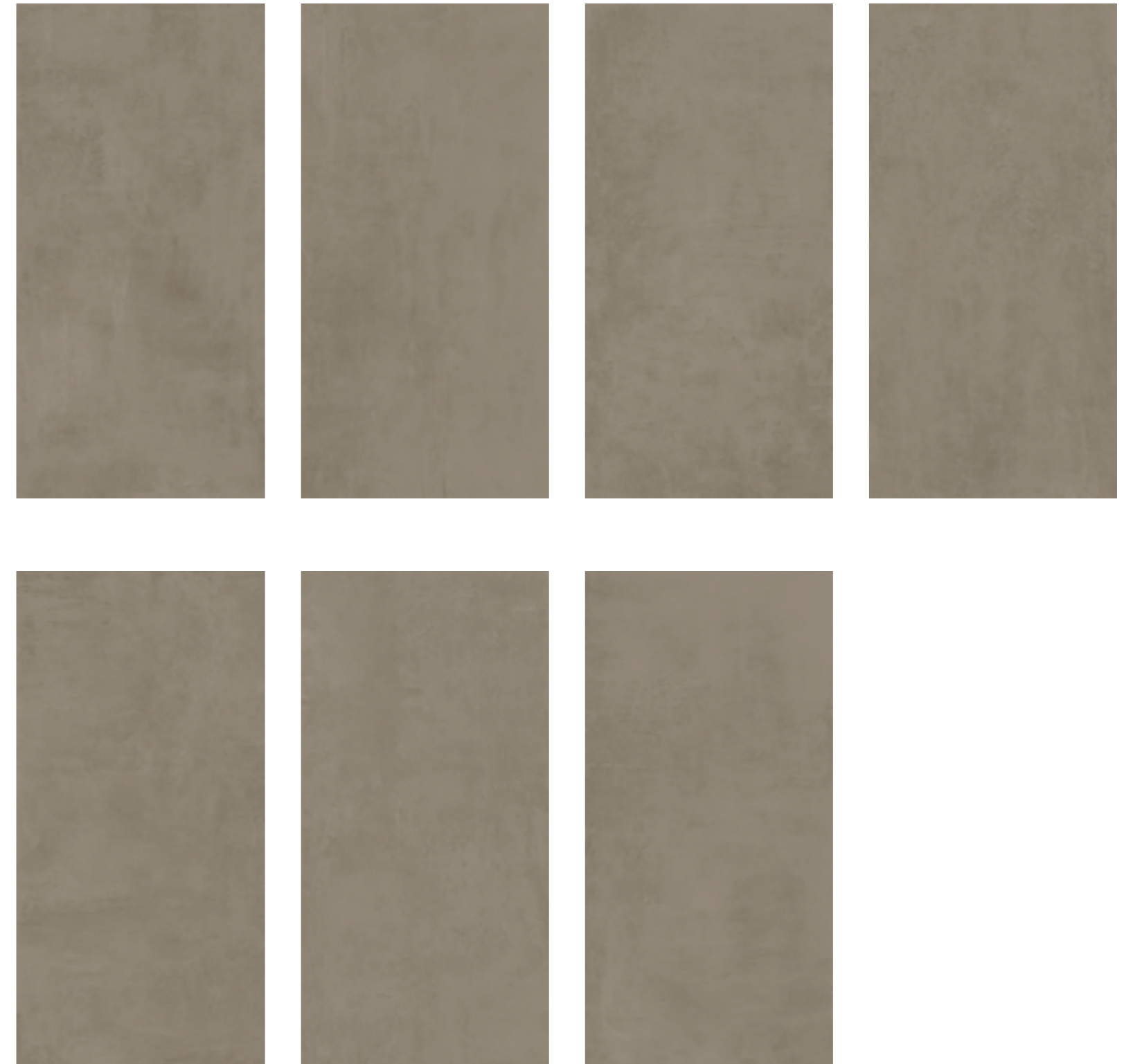

[BACK TO INDEX](#)



boost tarmac



SIZE	THICKNESS	FINISH	CODE
not rectified			
162 x 324 cm 63 3/4" x 127 1/2"	± 12 mm	Hammered	A65D

Also available in other sizes in the Atlas Concorde range.

[BACK TO INDEX](#)

boost tarmac



SIZE	THICKNESS	FINISH	CODE
rectified monocaliber			
160 x 320 cm 63" x 126"	± 6 mm	Hammered	A68J

Also available in other sizes in the Atlas Concorde range.

patterns



absolute white



SIZE	THICKNESS	FINISH	CODE
not rectified			
162 x 324 cm 63 3/4" x 127 1/2"	± 12 mm	Polished Matte	A4T4 AG1N
159 x 324 cm 62 3/4" x 127 1/2"	± 20 mm	Polished Matte	A1LY A1RU
rectified monocaliber			
160 x 320 cm 63" x 126"	± 6 mm	Matte	AJKR

absolute black



SIZE	THICKNESS	FINISH	CODE
not rectified			
162 x 324 cm 63 3/4" x 127 1/2"	± 12 mm	Matte	AG1G

black lava



SIZE	THICKNESS	FINISH	CODE
not rectified			
162 x 324 cm 63 3/4" x 127 1/2"	± 12 mm	Leathered	AF5A
	± 20 mm	Leathered	AF5M



blaze iron



SIZE	THICKNESS	FINISH	CODE
not rectified			
162 x 324 cm 63 3/4" x 127 1/2"	± 12 mm	Matte	A3ND

Also available in other sizes in the Atlas Concorde range.

Packaging

Atlas Plan slabs can be shipped in wooden crates or on A-frames made of wood or galvanized steel, according to the customer's choice.

Crates

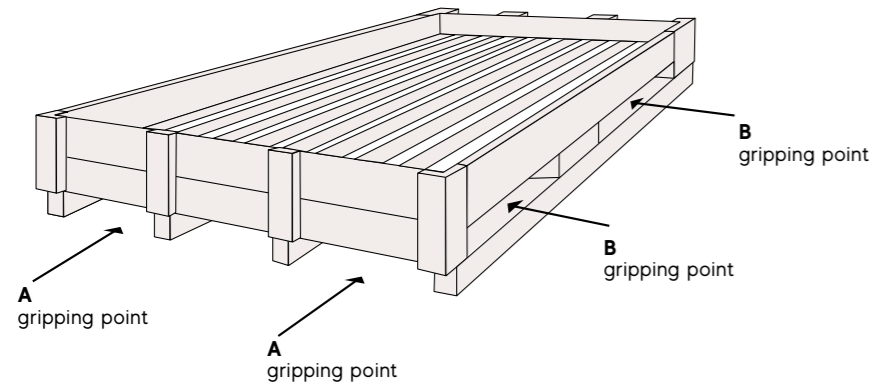

Crate storage

The wooden crates can be stacked on top of each other. Up to 7 crates can be stacked. Up to 9 crates can be stacked providing they are placed on a concrete floor. However, it is not possible to place a load of different size than that of the crate itself on top. The crates can be stored outdoors for up to 6 months.

MATERIAL	CERTIFICATION	EXTERIOR DIMENSIONS [MM - INCHES]	WEIGHT [KG - LBS]	GRIPPING POINTS
Wood	Structural and phytosanitary features*	3442x1745x374 135"x69" x15"	140 - 308,6	4-way (A or B)

*Phytosanitary certification refers to International Standard ISPM-15.

Transport in crates

THICKNESS [MM - INCHES]	SLABS LOADABLE IN CRATE	SQUARE METRES LOADABLE IN CRATE [M ² - SQFT]	CRATE WEIGHT IN MAXIMUM LOAD CONDITIONS [KG - LBS]*
20 - 3/4"	4	21 - 226	1106 - 2438
12 - 1/2"	8	42 - 452	1300 - 2866
6 - 1/4"	14	73.5 - 150,7	1155 - 2546

*weight tolerance of slabs 5%

A foam corner protection is applied when the slabs are loaded into the crates. A polystyrene sheet is placed on the bottom of the crate. The loading of each crate is then completed by applying a heat-shrink cap.

A-frame

Wooden A-frame

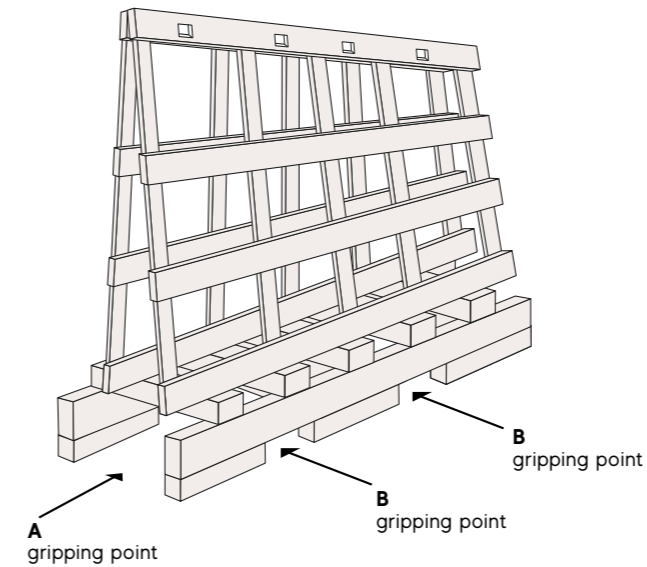

Steel A-frame

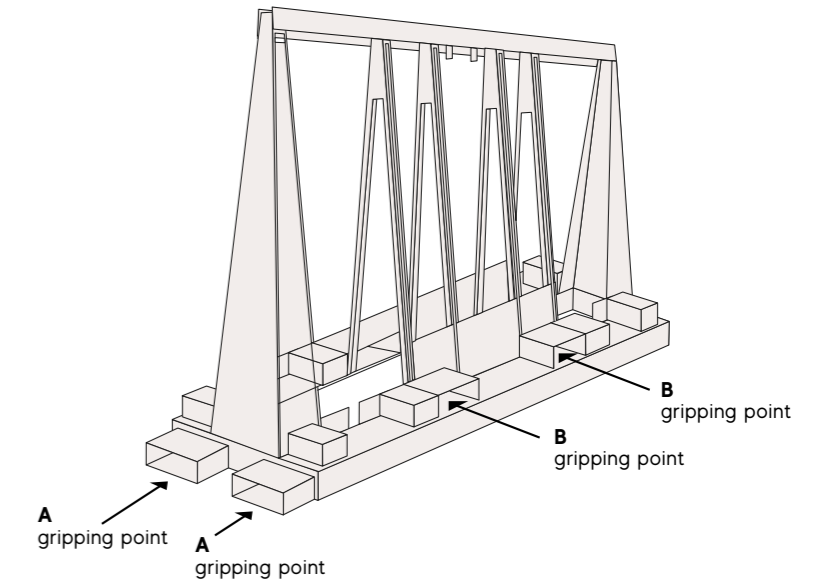

MATERIAL	CERTIFICATION	DIMENSIONS [MM - INCHES]	WEIGHT [KG - LBS]	GRIPPING POINTS
Wood	Structural and phytosanitary features*	3300x750x1953 130"x30" x77"	205 - 452	4-way (A or B)
Galvanised steel	Structural	3300x750x1950 130"x30" x77"	176 - 388	4-way (A or B)

*The structural certification refers to the following standards: UNI 91251, UNI EN 1995-1, UNI EN 12246, UNI EN 12248, UNI EN 636, UNI EN 12369-2; the phytosanitary certification refers to international standard ISPM-15.

A-frame storage

A third A-frame can be inserted upside-down between two wooden A-frames placed side-by-side to optimise empty A-frame storage space. Up to 6 galvanized steel A-frames can be stacked.

Transport on A-frames

SLAB THICKNESS [MM - INCHES]	SLABS LOADABLE ON A-FRAMES	SQUARE METRES LOADABLE ON A-FRAME [M ² - SQFT]	A-FRAME WEIGHT IN MAXIMUM LOAD CONDITIONS [KG - LBS]*	
			WOODEN A-FRAME	STEEL A-FRAME
20 - 3/4"	12	63 - 678	3103 - 6841	3074 - 6777
12 - 1/2"	22	115,5 - 1243	3400 - 7496	3366 - 7421
6 - 1/4"	42	220 - 2368	3250 - 7165	3221 - 7101

*weight tolerance of slabs equal to 5%

Once loaded, the slabs are fixed to the packaging by applying four vertical straps. The packaging is then covered by a heat-shrinkable cap. Incomplete loads must be balanced between the two sides of the A-frame.

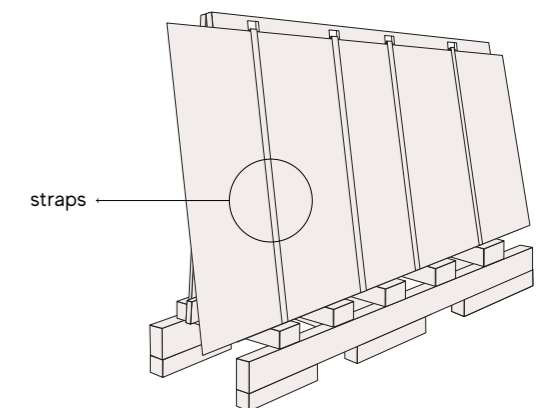

Bundles

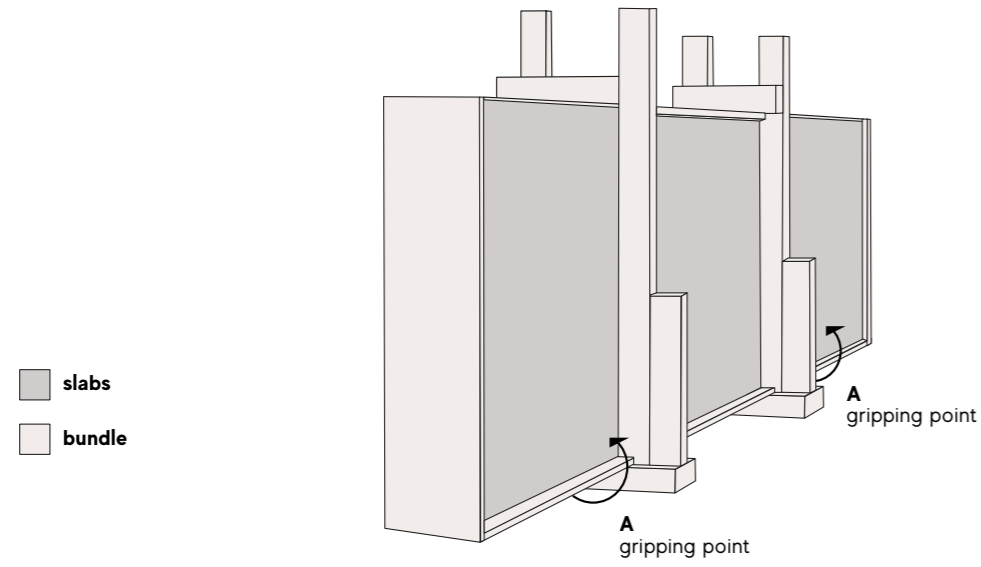

MATERIAL	CERTIFICATION	EXTERIOR DIMENSIONS [MM - INCHES]	WEIGHT [KG - LBS]	GRIPPING POINTS
Wood	Phyosanitary	3300x540x1800 130"x21"x71"	30-40 66-88	Base (A)

Bundles storage

Bundles can be stocked parallel on the ground. The bundles can be stored outdoors for up to 6 months. It is not recommended to store bundles outdoor for more than 6 months.

Transport on bundles

THICKNESS [MM - INCHES]	SLABS LOADABLE ON BUNDLES	SQUARE METRES LOADABLE ON BUNDLES [M² - SQFT]	BUNDLES WEIGHT IN MAXIMUM LOAD CONDITIONS [KG - LBS]*
12 - 1/2"	18	94,5 - 1017,2	2650 - 5842
20 - 3/4"	12	63 - 678	2920 - 6437,5

*weight tolerance of slabs 5%

